

AD-8118A

Journal Printer

INSTRUCTION MANUAL

owners-AD-8118A-V.3.a 90.11.14

AND
A&D Company, Limited



Table of Contents

Warranty.....	Page 3
Compliance with FCC Rules.....	Page 3
Introduction	
Welcome.....	Page 4
Features.....	Page 4
Specifications.....	Page 5
Description of Panels	
Front Panel.....	Page 6
Rear Panel.....	Page 6
Accessories.....	Page 7
Installation	
Best Conditions for Installation.....	Page 8
Connection of Power Supply/Ground.....	Page 8
Connection of Serial Input.....	Page 8
Serial Input Connection Table.....	Page 9
Connection of Control I/O.....	Page 10
Control I/O Connection Table.....	Page 10
Replacing the Printing Paper.....	Page 11
Replacing the Ink Ribbon.....	Page 12
Setting	
Setting the DIP Switches.....	Page 13
Function Setting Mode.....	Page 14
Time Setting Mode.....	Page 16
Date Formatting Mode.....	Page 17
Operation	
Operating the Switch Keys.....	Page 18
Operating the Control I/O.....	Page 19
Others.....	Page 21

Printing

Normal Characters.....	Page 22
Enlarged Characters	Page 23

Applications

Serial Inputs.....	Page 26
Connection to an Industrial Scale.....	Page 26
Connection to an Electronic Balance.....	Page 27
Connection to Peripheral Devices.....	Page 27
Connection to Other Devices.....	Page 28

Dimensions	Page 29
-------------------------	---------

Appendix

Character Code Table.....	Page 30
---------------------------	---------



Warranty

Warranty rights vary from country to country but it is the general intention of A&D Co., Ltd., to offer customers a one year warranty on this product from the day it is purchased. In some countries consumer protection legislation states that your dealer is responsible for offering a warranty and under these circumstances please refer to your local dealer.

In the U.S.A. the product (if defective) should be returned, freight prepaid by the customer, to A&D Engineering Inc. in California and in Europe the product can be returned freight prepaid to A&D Instruments GmbH in Frankfurt, West Germany. Elsewhere the product can be returned to A&D Co., Ltd. in Japan. In any event please contact your nearest A&D office before shipping, to confirm that the product is covered by this warranty. Simple repairs can be carried out by your local dealer under warranty and this may be the fastest method of solving your problem.

This warranty only applies to product failures due to defective materials and/or workmanship. This warranty will be rendered invalid if, upon inspection, it is found that the product was: Abused; used for a purpose for which it was not designed; mishandled; placed in a hostile environment; repaired by unauthorized personnel; improperly installed or not adjusted in accordance with instructions given in this manual.

If repair under warranty is confirmed by A&D, then the product will be repaired (or replaced, at the discretion of A&D) and then returned to the customer at no extra cost.



Compliance with FCC Rules

Please note that this equipment generates, uses and can radiate radio frequency energy. This equipment has been tested and has been found to comply with the limits of a Class A computing device pursuant to Subpart J of Part 15 of FCC rules. These rules are designed to provide reasonable protection against interference when equipment is operated in a commercial environment. If this unit is operated in a residential area it might cause some interference and under these circumstances the user would be required to take, at his own expense, whatever measures are necessary to eliminate the interference.

(FCC = Federal Communications Commission in the U.S.A.)



Introduction



Welcome!

*Thank you for your **A&D** purchase !*

This is an Instruction Manual for the AD-8118A Journal printer. The AD-8118A is a product of years of design, development, and in-field testing. It is designed to withstand harsh environmental conditions - and each printer is subjected to several levels of quality control before it leaves the factory. Every care has been taken during the manufacturing process of this printer to ensure that it will perform accurately and reliably for many years .

The AD-8118A Journal Printer is mainly for use with A&D's industrial scales and electronic balances. A highly reliable printer mechanism is perfect for industrial use, a watchdog circuit prevents malfunctioning and the AD-8118A is built solid to protect against noise influence. Easy to operate, the Journal Printer provides fast dependable printing.



Features

- Dot impact printing mechanism.
- Can print 24 columns per line.
- Easy connection to serial input cable.
- Small DIN size body can be mounted on panel.
- Cumulative total function by code.
- Calendar/clock function.
- A lithium battery provides cumulative total and calendar back-up without AC power for approximately 6 years.
- 60 mm paper used for large printing capacity.



Specifications

Printer Specifications	
Printing system	Mechanical type dot impact printer
Printing width	24 columns/line for 5 x 7 dot character 12 columns/line for 10 x 7 dot character (enlarged character)
Printing speed	Approximately 1.7 line/second (internal processing time excluded)
Dimensions of character	1.7 (W) x 2.6 (H) mm 3.4 (W) x 2.6 (H) mm (enlarged character)
Reliability	1,000,000 lines
Ink ribbon (ERC-09)	
Color of character	Purple
Life	250,000 characters (varies depending on environment)
Printing paper (PP-137)	
External dimensions	57.5 (W) x 60 (diameter) mm
Length	Approximately 30m (an ending mark appears approximately 1 m from the end.)

General Specifications	
Power supply	100, 117, 220, 240V AC +10% / -15%, 50/60 Hz
Weight	Approximately 3 kg
Operating temperature range	-5°C to 40°C(23°F to 104°F)
Maximum humidity	80 %RH (non-condensating)
Physical dimensions	192 (W) x 185 (D) x 96 (H) mm
Dimensions of panel cut	186 +1.0/-0 x 92 +0.8/-0 mm

Input Specifications	
Method	EIA RS-232C or 20 mA current loop (PASSIVE)
Baud rate	2400/600 bps
Data bits	7/8 bits
Parity bit	1 (EVEN) / 0
Stop bit	1
Codes used	ASCII or JIS



Description of Panels



Front Panel

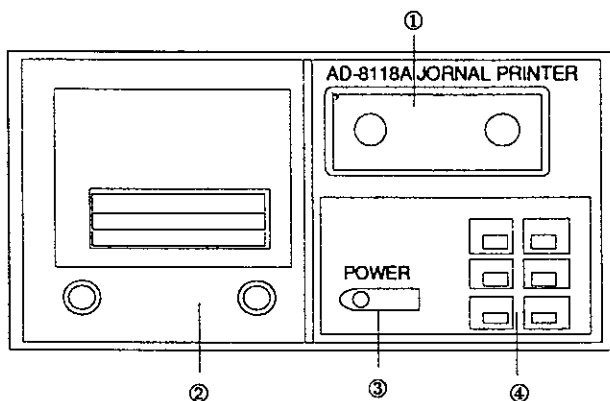

- ① Cover for setting section
Remove this cover and use the DIP switches to set, otherwise keep it attached to prevent dust from getting inside.
- ② Printer cover
Remove this cover to change printing paper and/or ink ribbon.
- ③ POWER indicator
This lights up when the power is on.
- ④ Operation keys
For operation, refer to "Operating the Switch Keys," .



Rear Panel

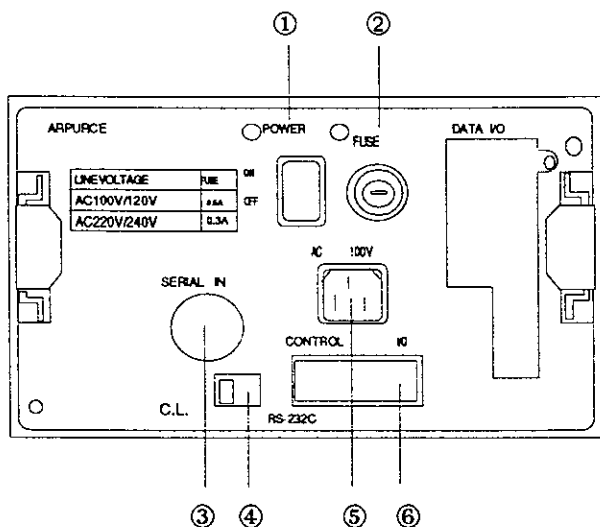

- ① POWER switch
Turn OFF when not using.
- ② Fuse
0.5A 100V to 120V(blow)
0.3A 200V to 240V(blow)
- ③ Standard serial input connector
Input of RS-232C or current loop for data.
Refer to "Connection of Serial Input," .
- ④ Select switch for input mode
This switch is used to select RS-232C or current loop for serial inputs. Refer to "Serial Inputs," .
- ⑤ Connector for power cable
Refer to "Connection of Power Supply/Ground," .
- ⑥ Connector for control I/O
This is the I/O area that controls the printer. Refer to "Connection of Control I/O," .



Accessories

AC cable	1	Printing paper (PP-137)	1
Fuse	1	Ink ribbon (ERC-09 by Epson)	1
0.5A 100V to 120V(blow)		I/O connector	1
0.3A 200V to 240V(blow)		DIN connector	1
		Rubber legs	4



Installation



Best Conditions for Installation

Be careful when handling this unit because it is a precision electronic device.

- 1) Don't install the AD-8118A in direct sunshine. Avoid places where there are sudden temperature changes, vibrations, strong winds and excessive moisture or dirt.

Also, keep away from conductive substances such as carbon powder. If these substances get inside the unit errors can occur.

- 2) The best temperature setting is about 20°C (68°F) at 50% relative humidity.
- 3) Be careful not to expose the unit to excessive noise or static electricity, this may cause malfunctioning.



Connection of Power Supply/Ground

- 1) Earth the AD-8118A via the power cable to the rear terminal of your scale or balance. Don't plug it in directly to any other equipment. Do not use it commonly with power devices.
- 2) If the local AC electricity supply fluctuates by more than $\pm 10\%$ an AC regulator must be used to stabilize the power supply. Do not use a common source for the power lines.



NOTE: Do not turn ON the power at this time. Connect the power plug after all other connections have been made.



Connection of Serial Input

The Serial Input on the rear panel can be connected with either the RS-232C input or the current loop input. Select the appropriate input with the slide switch also located on the rear panel.

Direct Connection

The Serial Input can be connected with a standard serial output or current loop on A&D Weighing Indicators.(ex. AD-4322A, AD-4323, AD-4324,AD-4325A)

Using the Optional Interface

The Serial Input can be connected with a RS-232C input or current loop input using an RS-232C optional interface. This can be done with the FX, FY, FR, FV, FW and AD-4316 or AD-4321. (If the option is provided with a current loop output, it can be used as well.)

Note that these units are equipped with outputs that can be connected to the AD-8917, AD-8918, AD-8117 and AD-8118A externally.

Serial Input Connection Table

Pin No.	Abbreviation	Description
1	C.L.OUT	Current loop output
2	F.G	Frame ground
3	Ser. IN+	Serial input + (TxD)
4	GND	Signal ground
5	Ser.IN-	Serial input - (SG)
6	I.C	For internal use
7	I.C	For internal use

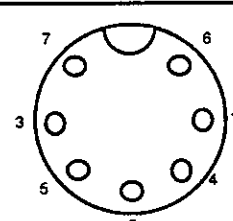

Viewed from rear panel

- The Serial Input is commonly used for the RS-232C and the current loop. On a RS-232C connection, pin No. 5 is used as the signal ground; connect the shield to pin No. 2.
- Signal lines using a twist-pair shielded cable should work better. This is diagrammed below:

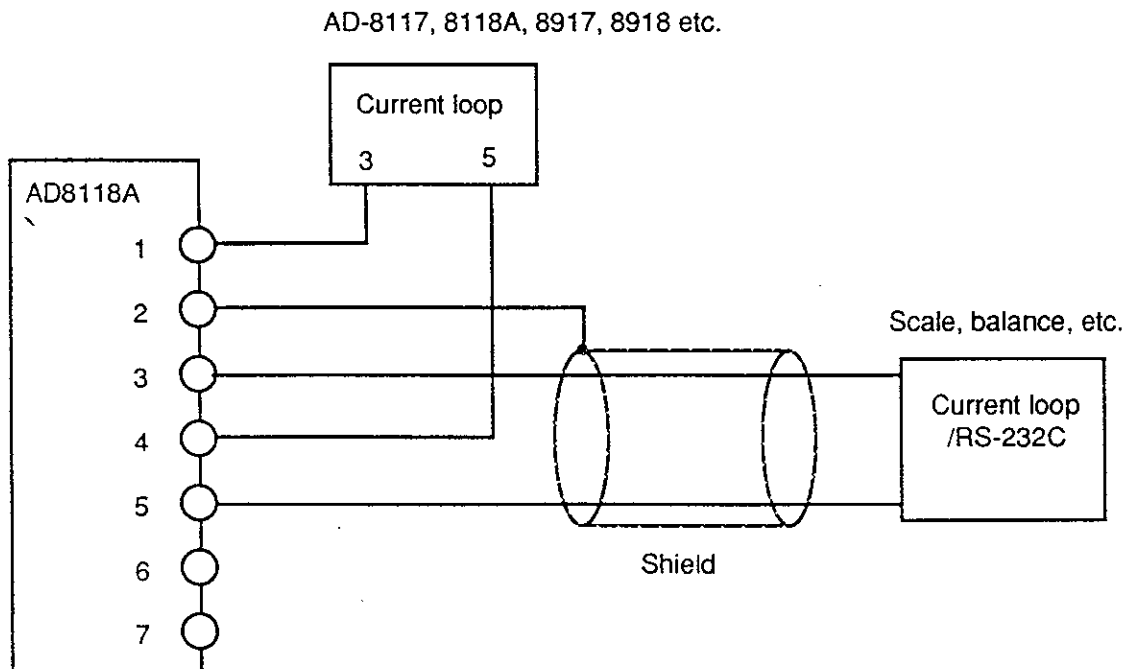



Connection of Control I/O

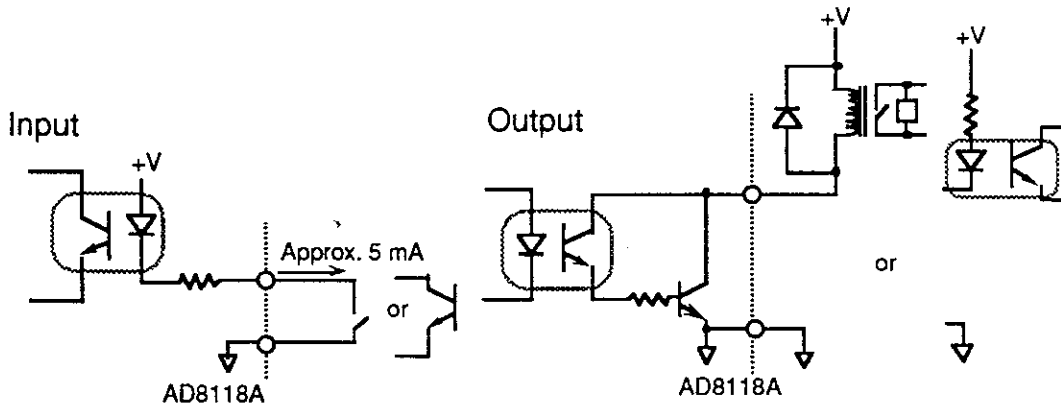

- This is the Interface circuit of the Control I/O .
- Please use an optical isolator or relay.
- The extension, or driving capacity of these relays is 24V 50mA DC maximum.
- The width of these inputs are at least 100msec.



Control I/O Connection Table

Pin No.	Description	Pin No.	Description
A 1	Code input (BCD)	B 1	Grand total printing command input
2		2	Delete command input
3		3	Cumulative total delete command input
4		4	Input for disable printing time
5		5	Busy output
6		6	Printing announcement
7		7	N.C.
8		8	Output common
9	Printing command input	9	For internal use
10	Paper feed command input	10	Input common
11	Addition command input	11	Input common
12	Subtotal printing command input	12	F.G.

The Pins to change the Control I/O specifications are located on the rear panel. See drawing below:

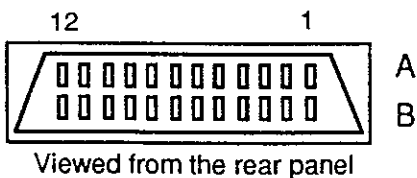

The inputs are operated by short-circuits. The input is a pulse that has a coded input. These pulse widths are 100 msec. or longer.

The output is operated by the output transistor turning ON.



Note

The data will only print when the "Input for disable printing time" Pin # B-4 is shorted.



Replacing the Printing Paper

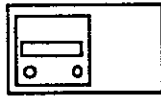

Front View

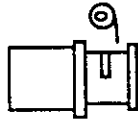

Side View

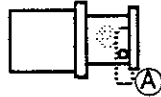

Side View



Front of Printer



Paper Roll



Side of Printer

1. First, turn the power OFF.
2. Loosen the screws on the printer cover and draw out the printer unit.
3. Peel off the adhesive tape on the printing paper (PP-137) completely, insert the shaft provided as an accessory and set the paper. (Be careful of the direction of the paper.)
4. After setting the paper to the holder, take out the paper and insert it into the opening labeled "A" on the printer through the lower side of the roller, as shown to the left.
5. With the paper inserted, turn the right knob of the printer unit in the direction of the arrow shown to the left; the paper should come out the front.

If the paper fails to come out, check for a bend or fold in the paper. If it is difficult to insert, fold the top over a few centimeters.

If the ink ribbon needs adjusting turn the knob of the ink ribbon to give tension to it.

6. Return the unit to its original position and tighten the screws on the printer cover.



Note 1: Do not apply excessive force to the printer unit. If normal, it can be drawn out easily. If it is hard to take out return it once and draw it out again. The guide may be damaged if excessive force is applied vertically or horizontally.



Note 2: The printer is made of precision components and could be damaged if metallic powder, water or other foreign substance get inside the printer. Also be careful of static electricity when the printer is drawn out.

If dust and other foreign substance get inside the unit, blow it out with clean air. If the unit is used in a dusty environment consider using a dust cover or air purge when not in use.



Note 3: A red mark will be printed approximately 1m before the end of the roll of paper; replace the paper when you see this mark.

Replacing the Ink Ribbon



Front of Main Unit

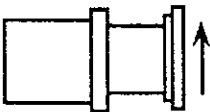

Side of Main Unit

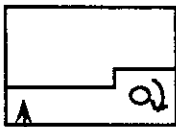

Front of Printer



Printer Unit

1. First, turn the power OFF.
2. Loosen the screws on the printer cover and draw out the printer unit. Remove the printing paper. (Refer to "Replacing the Printing Paper," p. 10.)
3. Remove the printer cover carefully; it can be detached from the unit by lightly lifting up.
4. Remove the old ink ribbon by lifting it up when the arrow position of the printer unit is pushed.
5. Set the new ink ribbon in place being careful not to roll the ribbon. After the ribbon is in place, turn the right knob of the ink ribbon in the direction of the arrow shown in the figure to the left.
6. Reattach the printer cover by setting the bosses and sliding the cover down.
7. Set the printing paper, see page 11.
8. Return the unit to its original position and tighten the screws on the printer cover.

Note 1: Do not apply excessive force to the printer unit. If normal, it can be drawn out easily. If it is hard to take out return it once and draw it out again. The guide may be damaged if excessive force is applied vertically or horizontally.

Note 2: The printer is made of precision components and could be damaged if metallic powder, water or other foreign substance get inside the printer. Also be careful of static electricity when the printer is drawn out.

If dust and other foreign substance get inside the unit, blow it out with clean air. If the unit is used in a dusty environment consider using a dust cover or air purge when not in use.



Settings



Setting the DIP Switches

The DIP switches control the conditions of printing. Open the cover on the front panel (refer to "Front Panel," p. 6) and set the DIP switches. The DIP switch options are as follows:

Switch No.	Contents	OFF	ON
1	Baud rate	2400bps	600bps
2	Data bit	7bit (even parity check)	8bit (no parity)
3	Printing mode	Dump print	Standard format
4	Printing form	Normal characters	Inverted characters
5*	Minus/unstable	Accepted	Not accepted data
6	Printing characters	Standard characters	Enlarged characters
7	Key input	Enabled	Disabled
8	Setting mode	Normal mode	Setting mode change

All switches are turned OFF without No.3 when shipped from our factory so make changes according to your needs. Note that switch #5 is available only in the standard format.

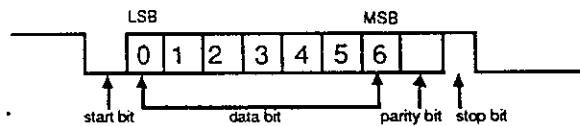

The DIP switch explanations are described beginning below:

Baud rate Switch #1

Baud rate is the speed of transmitting data. It can be changed by the DIP switch #1. Choose either a faster 2400bps or normal 600bps speed. Choose 600bps to avoid errors caused by the expansion of the cable.

Data bit Switch #2

Data bits are the bits used to transfer one character of data; 7 bits or 8 bits are available. Even parity is performed on 7bit data.

Printing mode Switch #3

Dumb printing is simply having all print formatting controlled by an external device. All function keys and inputs are disabled except for the FEED key.

The **Standard format** results in data after the output from an A&D industrial scale or electronic balance is internally processed and formatted. Printing timing, cumulative total, etc. are taken. (For the input data of the standard format, refer to "Applications," p. 21.)

Printing form Switch #4

Select the printing direction.

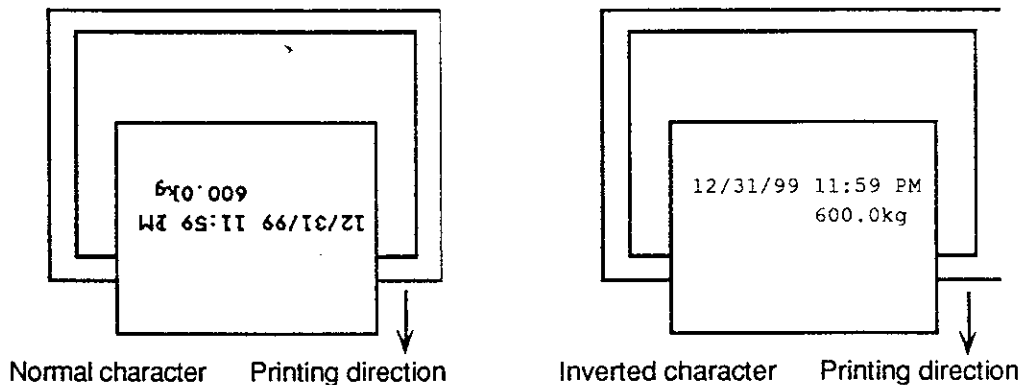

When Normal characters are selected they seem to be inverted during printing, but the printing process is the same as the input data process.

Inverted characters selected seem to be normal, but the printing process is the opposite of the input data process.

Status printing Switch #5

Changes over to enable/disable the data at minus/unstable.

Printing character Switch #6

Choose either standard character size (5 x 7 dots) or enlarged (10 x 7).

Key input Switch #7

Enable or disable the key inputs from the front panel.

Setting mode change Switch #8

If this DIP switch is selected the unit is in the setting mode explained below.



Function Setting Mode

Setting mode can only be accessed when **DIP switch #8** is turned ON. Then, while pressing the **SET UP** key, press the **M+.PRT.** key at the same time. The following message is printed:

FUNCTION 1 1

You are now in the Function mode, press the **TOTAL** key to change the Function No. and same format used for printing. Press the **M+.PRT.** key to increase the function level, press the **CLEAR** key to decrease the function level.

The **FEED** key will advance the paper by one line and the **PRINT** key will print the function message and the data currently in the setting format.

Press and immediately release the **SET UP** key to update and escape the Function mode. The functions will be printed and the unit will return to setting mode.

F1-1,F2-2,F3-1,F4-1

FUNCTION SET END

Function Mode Options

F1-Printing Mode

There are two types of F1 printing modes:

- (1) **The Auto mode** prints input data automatically. The printing timing can be controlled either manually or by using the auto printing mode.
- (2) **The Manual mode** only prints when the **PRINT** key is pressed or a command is input. The printing timing can be controlled on the main unit if the device connected is set to stream.

Set value of F1	Printing mode	Description
F1 - 1	Manual printing 1	Adds and prints at addition printing. (initial setting)
F1 - 2	Manual printing 2	Adds only at addition printing.
F1 - 3	Auto printing	Prints the data.
F1 - 4	Auto addition	Adds the data.
F1 - 5	Auto addition/printing	Adds and prints the data.

F2- Lines to feed

Sets the number of feeding lines after printing the data or the cumulative total by a number from 0 to 9, default is "2".

F3- Input mode

Select either gross weight, net weight, tare weight, or all three. This function is used when connecting a weighing indicator (ex. AD-4322, AD-4323, AD-4325A) to several peripheral devices (external indicator, etc.) (refer to "Connection to Peripheral Devices,"). Otherwise, set to "1 (All enable)."

Set value of F3	Input mode
F3 - 1	All enable (initial setting)
F3 - 2	Gross weight
F3 - 3	Net weight
F3 - 4	Tare weight

F4- Statistics mode

This mode can get maximum data ,minmum data ,average data ,standard deviation, sample range of cumulated data and prints out these. The Statistics caluclates all data no concerning with code data.

Set value of F4	mode
F4 - 0	No caluclation of statistics (initial setting)
F4 - 1	Sample deviation (σ_{n-1})
F4 - 2	Standard deviation (σ_n)

Time Setting Mode

Press the **TOTAL** key while at the same time pressing the **SET UP** key. Now change the date and time to their correct settings. You will be prompted with the following screen:

```
| 10/26/90 2:35 PM |  
| ^                |
```

To set the date and time use the following keys:

- TOTAL** key Shifts the "^" mark to the right, the "^" mark indicates which input can be changed.
- M+.PRT** key Increases the number.
- CLESR** key Decreases the number.
- SET UP** key Press the **SET UP** key when done. This stores the date and time to memory and the following message is printed:

```
| 10/26/90 7:35 AM |  
| CLOCK SET END   |
```

If any set value is wrong a message is printed, the value is not stored and the unit remains in the time setting mode. Set the value again.

```
| 10/66/90 7:35 AM |  
| ^                |  
| CLOCK SET ERROR  |
```



Date Formatting Mode

You can select from the following date formats:

American type:	6/22/90	10:47	AM
European type:	22/6/90	10:47	AM
Japanese type:	90*6*22*	10*47*	AM

To change date format:

- Step 1** Turn off the power switch on the rear panel.
- Step 2** Turn back on the power switch while pressing the **SET UP** key and **M+.PRT** key at the same time.
- Step 3** Press the **CLEAR** key to rotate through the three types. The type selected will be printed as the **CLEAR** key is pressed.

American type		U.S.A.
European type	<or>	EUROP
Japanese type	<or>	JAPAN

- Step 4** Turn off the power switch.
- Step 5** Everything in Setting Mode has been saved. Return **DIP switch #8** to the OFF position.



Operation



Operating the Switch Keys

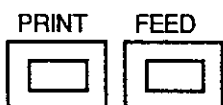

FEED key

Press this key to advance one line. Hold it pressed to feed continuously.

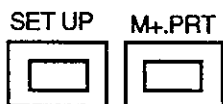

PRINT* key

Press this key to print a line of data input. If no data is input within 3 seconds, "T ERROR" will be printed. If the format does not match, "F ERROR" will be printed.

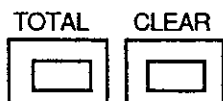

M+.PRT* key

Press this key to add an input data before printing. If no data is input within 3 seconds a "T ERROR" is printed. If the format does not match, "F ERROR" is printed.

CLEAR key

Press **M+.PRT** key while pressing the this key to delete the last data from the cumulative total. The following is printed:

***CANCEL**

Press **TOTAL** key while pressing the this key to clear the cumulative total and number; the following is printed:

***CLEAR**

TOTAL key

Press this key to print the cumulative total (grand total) separating the total weight by code and the gross total weight.

SET UP key

Press this key to set functions, etc. in the setting mode. Refer to "Function Setting Mode," p. 14 for details.

The keys marked with "*" are disabled in Auto printing mode. In Dump printing all functions, other than the **FEED** key and the **SET UP** key, are disabled.



Operating the Control I/O

Inputs

Code	The value is printed on the left side of the paper when addition printing is done. This value is stored with the weight value and can be retrieved by code as well. This code is not printed if the value is "00," only numbers from 01 to 99 can be used.
Print command*	When this input is negative low (short), the first data input within 3 seconds is printed.
Paper feed command	This command advances the paper one line, negative low(short).
Addition print command *	When this input is negative low(short), the first data input within 3 seconds is added and printed.
Subtotal printing command	This command prints the subtotal value and clears after printing.
Grand total printing command	This command prints the grand total value and does not clear the subtotal or grand total after printing.
Delete command	This command deletes the last added data from the cumulative total value and then prints the message "*CANCEL" . It is unable to perform this command if there is no cumulative total value.
Cumulative total delete command	This command deletes the cumulative total value and then prints the message "*CLEAR" . It is unable to perform this command if there is no cumulative total value.
Input for disable printing time	Time printing is disabled while this input is ON. Once OFF, the time printing is performed once more on the next printing time. In cumulative total printing, time printing is performed regardless of the input.
<u>Outputs</u>	
Busy	This output is turned ON when the data buffer exceeds 75 lines.
Printing announcement	This output is turned ON when the unit is printing. Control inputs are not accepted during this time. Therefore, enter the control input when this output is OFF.

The inputs marked with "*" are disabled in Auto printing mode. In Dump printing, all functions except paper feed are disabled.

Each command input is judged at the negative edge and actuated only when it is turned ON.

Input is accepted when turned ON (short-circuited) continuously for 100 ms or longer.



Others

Printing buffer

This unit has a printing buffer of 80 lines. If data can not be printed the data is stacked in this buffer and cleared as the printing progresses. If this buffer exceeds 75 lines the "Busy Output" from the I/O is turned ON. "B ERROR" is printed once when the buffer exceeds 80 lines. The printing speed is 1.7 lines/sec, do not input the data faster than this speed.

Error printing

This unit recognizes the following errors and prints them:

Error printing	Description
T ERROR	A time out in manual printing.
U ERROR *1	Appears when the unit is different than the last data unit in cumulative total mode
S ERROR *2	Appears when the cumulative total weight is too much.
O ERROR	Appears when an input is too much.
F ERROR	Appears when the data format does not match.
I ERROR	Appears when needless data (-, unstable data) is input
B ERROR	Appears when the printing buffer is activated.
R ERROR*3	Appears when numbers other than "00" to "99" are input as a code input.

- *1 This message prints the weight value and accepts to the cumulative total.
- *2 This message prints the weight value but does not add the data to the cumulative total.
- *3 This message prints the weight value and accepts to the cumulative total as code No. 00.

Proceduer of power on

Frist, plesase power on other insturments conecting to this printer and power on this printer. If you power on other insturments with this printer at same time and use automatic print mode or dumb print mode, frist data can not often caluclates. In manual print mode, No problem after inputting several data to this printer.



Printing



Normal Characters

Normal printing

Greater Code

8/11/99	8:00 AM		
CD99	GS+	200.0kg	Weight value
			Code number



Error code is printed from prior Error code.
Code priority as follow :
O ERROR>S ERROR>U ERROR>F ERROR>I ERROR
Reference page 21

Addition printing

8/11/99	8:00 AM		
#	1 CD99 GS+	200.0kg	Cumulative total counting number



Cumulative total by Code is not Printed, when only 'Code No.00' is entered, and No other Code No is followed. (Control I/O is not connected).

Subtotal printing

Error code

SUB TOTAL			
8/11/99	10:05 PM		
0	1T	50.02kg	Cumulative total by code (times : 4 digits, cumulative total : 9 digits)
CD 1	1T	3.012kg	
CD99	1T	200.0kg	
JT		253.032kg	
			Number of times

SUB TOTAL				
8/11/99	10:06 PM			
0	1T	50.02kg	Cumulative total by code (times : 4 digits, cumulative total : 9 digits)	
CD 1	1T	3.012kg		
CD99	1T	200.0kg		
JT		253.032kg		Gross cumulative total (times : 6 digits, cumulative total : 11 digits)
MAX		200kg	Average of data	
MIN		3.012kg		
\bar{x}		84.344kg		
σ_n		102.8818kg		Sample deviation
R		196.988kg		Range of data

SUB TOTAL				
8/11/99	10:07 PM			
0	1T	50.02kg	Cumulative total by code (times : 4 digits, cumulative total : 9 digits)	
CD 1	1T	3.012kg		
CD99	1T	200.0kg		
JT		253.032kg		Gross cumulative total (times : 6 digits, cumulative total : 11 digits)
MAX		200kg	Average of data	
MIN		3.012kg		
\bar{x}		84.344kg		
σ_n		84.0027kg		Standard deviation
R		196.988kg		Range of data

Grand Total printing

GRAND TOTAL		
8/11/99 10:05 PM		
0	1T	50.02kg
CD 1	1T	3.012kg
CD99	1T	200.0kg
	3T	253.032kg

Cumulative total by code (times : 4 digits, cumulative total : 9 digits)

Gross cumulative total (times : 6 digits, cumulative total : 11 digits)

GRAND TOTAL		
8/11/99 10:06 PM		
0	1T	50.02kg
CD 1	1T	3.012kg
CD99	1T	200.0kg
	3T	253.032kg
MAX		200kg
MIN		3.012kg
\bar{x}		84.344kg
σ_n		102.8818kg
R		196.988kg

Cumulative total by code (times : 4 digits, cumulative total : 9 digits)

Gross cumulative total (times : 6 digits, cumulative total : 11 digits)

Average of data

Sample deviation

Range of data

Maximum data

Minimum data

GRAND TOTAL		
8/11/99 10:07 PM		
0	1T	50.02kg
CD 1	1T	3.012kg
CD99	1T	200.0kg
	3T	253.032kg
MAX		200kg
MIN		3.012kg
\bar{x}		84.344kg
σ_n		84.0027kg
R		196.988kg

Cumulative total by code (times : 4 digits, cumulative total : 9 digits)

Gross cumulative total (times : 6 digits, cumulative total : 11 digits)

Average of data

Standard deviation

Range of data

Maximum data

Minimum data



Enlarged Characters

Normal Printing

Code number	
8/11/99	8:00 AM
CD99	
GS+	200.0kg

Addition Printing

Cumulative total counting number	
8/11/99	8:00 AM
#	1 CD99
GS+	200.0kg

Subtotal Printing

SUB TOTAL	
8/11/99 10:05 PM	
0	1T
CD 1	50.02kg
	1T
CD99	3.012kg
	1T
	200.0kg
	3T
	253.032kg

Error code
 Number of times
 Cumulative total by code (times : 4 digits, cumulative total : 9 digits)
 Gross cumulative total (times : 6 digits, cumulative total : 11 digits)

SUB TOTAL	
8/11/99 10:06 PM	
0	1T
CD 1	50.02kg
	1T
CD99	3.012kg
	1T
	200.0kg
	3T
	253.032kg
MAX	200kg
MIN	3.012kg
X	84.344kg
σ_n	102.8810kg
R	196.988kg

Cumulative total by code (times : 4 digits, cumulative total : 9 digits)
 Gross cumulative total (times : 6 digits, cumulative total : 11 digits)
 Maximum data
 Minimum data
 Average of data
 Sample deviation
 Range of data

SUB TOTAL	
8/11/99 10:07 PM	
0	1T
CD 1	50.02kg
	1T
CD99	3.012kg
	1T
	200.0kg
	3T
	253.032kg
MAX	200kg
MIN	3.012kg
X	84.344kg
σ_n	84.0027kg
R	196.988kg

Cumulative total by code (times : 4 digits, cumulative total : 9 digits)
 Gross cumulative total (times : 6 digits, cumulative total : 11 digits)
 Maximum data
 Minimum data
 Average of data
 Standard deviation
 Range of data

Grand Total Printing

```

GRAND TOTAL
8/11/99 10:05 PM
  0      1T
    50.02kg
CD 1      1T
    3.012kg
CD99      1T
    200.0kg
      3T
    253.032kg
    
```

Cumulative total by code (times : 4 digits,
cumulative total : 9 digits)

Gross cumulative total (times : 6 digits,
cumulative total : 11 digits)

```

GRAND TOTAL
8/11/99 10:06 PM
  0      1T
    50.02kg
CD 1      1T
    3.012kg
CD99      1T
    200.0kg
      3T
    253.032kg
MAX      200kg
MIN      3.012kg
X        84.344kg
σn-1    102.8818kg
R        196.988kg
    
```

Cumulative total by code (times : 4 digits,
cumulative total : 9 digits)

Gross cumulative total (times : 6 digits,
cumulative total : 11 digits)

Maximum data

Minimum data

Average of data

Sample deviation

Range of data

```

GRAND TOTAL
8/11/99 10:07 PM
  0      1T
    50.02kg
CD 1      1T
    3.012kg
CD99      1T
    200.0kg
      3T
    253.032kg
MAX      200kg
MIN      3.012kg
X        84.344kg
σn      84.0027kg
R        196.988kg
    
```

Cumulative total by code (times : 4 digits,
cumulative total : 9 digits)

Gross cumulative total (times : 6 digits,
cumulative total : 11 digits)

Maximum data

Minimum data

Average of data

Standard deviation

Range of data



Applications



Serial Inputs

The serial input can be changed through the RS-232C to current loop by the slide switch on the rear panel. Select either one depending on the product being connected. The power for the current loop is supplied by the receiving side.

When using the RS-232C the following cables are useable:

For **current loop** (DIN7P-DIN7P) Note 1:

KO : 359- 200

KO : 359- 400

KO : 359- 600

KO : 359- 800

KO : 359-1000

KO : 359-1200

KO : 359-1400

For **RS-232C** (DIN7P-DSUB25P):

KO : 360- 200

Hint: "KO : 359-200" is a 200 cm, or 2 m cable for the current loop.



Note1: When connecting option OP-03 (RS-232C option) from a FV or FW, use a cable for the current loop.

Set the connected instrument to stream, auto print or manual print mode. The command mode can not be supported. In addition, if the standard format input is set through the unit, inputs are not accepted on rare occasions. Set the unit to **Dump print** in such a case.



Connection to an Industrial Scale

The standard format of A&D industrial scales are as follows:

AD-4316	+	OP-04 *1
AD-4321A/B	+	OP-04
AD-4322A		(OP-04) *2
AD-4323		(OP-04)
AD-4324		(OP-04)
AD-4325A		(OP-04)
FV series	+	OP-03
FW series	+	OP-03

*1 A unit with "+OP-xx" means that it is necessary to pair this option.

* 2 A unit with "(OP-xx)" can connect to the standard serial output.

Please set the DIP switches according to the specifications of these units. When connecting to an AD-4325A, cumulative total can be started by the codes of the AD-4325A if set to the output of format with the correct code. Set the printer mode on DIP switch #3 to standard format. AD-4601 has RS-232C. Set print mode of RS-232C Function . you can input standerd format data. (The flow speed can't be input; In this case ,set dump printing mode.) ,



Connection to an Electronic Balance

The standard format of A&D's electronic balances are as follows:

EP series + OP-03
ER series + OP-03
ET series + OP-03
FX series + OP-03
FY series + OP-03
FC series + OP-03
EK series + OP-03
FR series + OP-03

Set the DIP switches according to their specifications.



Connection to Peripheral Devices

This unit has the functional ability to send outputs, as well as input data, through the current loop. This allows connection to the AD-8916, AD-8917, AD-8918, AD-8117 and AD-8118A.

For example, if two AD-8917's are connected, the setting of gross weight, net weight and tare weight output through the serial output of an AD-4322A, AD-4323 or AD-4325A can be achieved. The following application will then be realized:

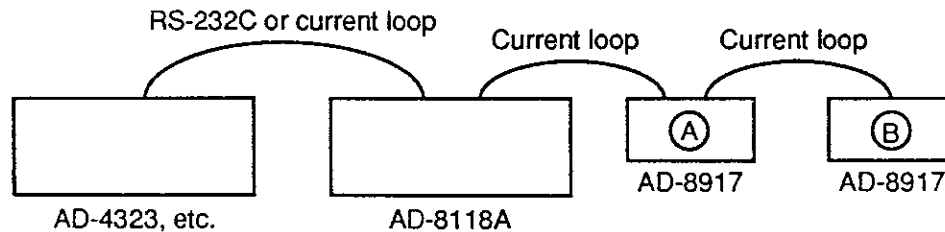

In the above example, the gross weight is displayed in the AD-8917 "A" and the tare in the AD-8917 "B". Then the net weight data is printed on the AD-8118A and the cumulative total is calculated. Note that this printer can't be connected to more than two other units.



Connection to Other Devices

If this printer is connected to a personal computer, a sequencer or any other unit set this unit to the RS-232C and Dump print. Set the DIP switches appropriately. For characters to print, refer to the "Character Code Table" in the **Appendix**, p. 30. This unit only receives signals, it can't output control signals, message, etc. Note that overflow of the data buffer is valid for control I/O only.

The following codes have meaning as control signals:

0DH----- Moves a character point to the beginning of the next line and clears the specification of an enlarged character.

0EH----- An enlarged character can be used with this signal.

14H----- If this code is input while in the enlarged character mode it changes back to the normal character mode. This command is ignored when in normal character mode.

1BH----- This code is used in combination with the following two characters as an auxiliary code:

1BH+44H Prints the year, month and day.

1BH+54H Prints the time.



Dimensions

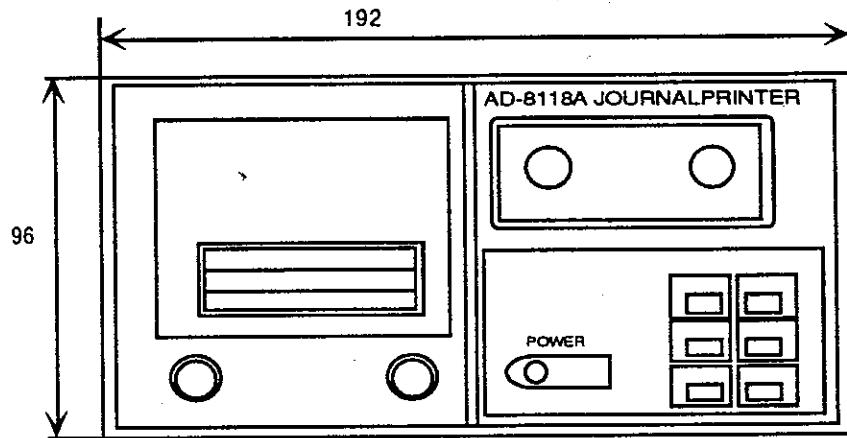

FRONT VIEW

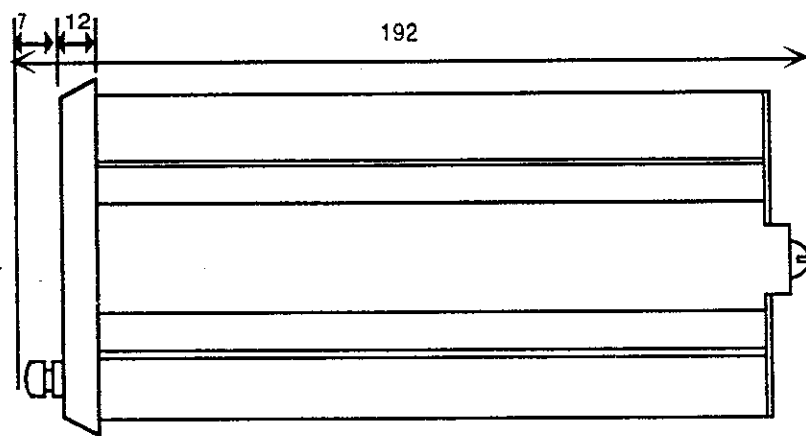

SIDE VIEW

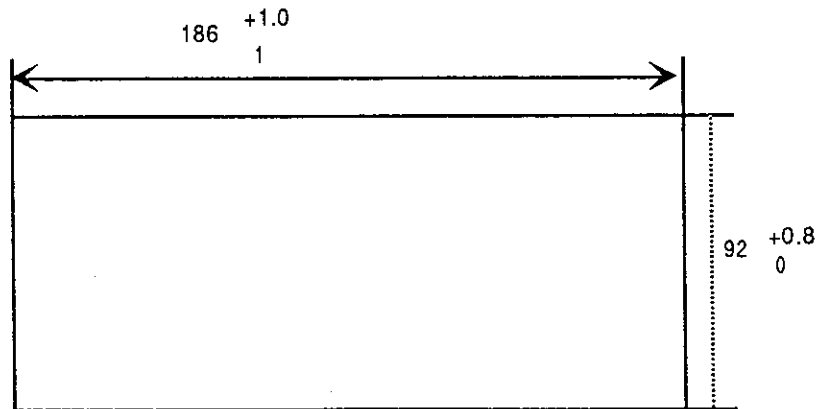



Appendix



Character Code Table

HEX.N	0	1	2	3	4	5	6	7	8	9	A	B	C	D	E	F
0	NUL		(SP)	`	@	P	´	p	µ	⊥						
1			!	1	A	Q	a	q	—	⊥						
2			"	2	B	R	b	r	—	†						
3			#	3	C	S	c	s	—	†						
4			\$	4	D	T	d	t	—	—						
5			%	5	E	U	e	u	—	—						
6			&	6	F	V	f	v	—							
7			'	7	G	W	g	w	—							
8			(8	H	X	h	x		r						
9)	9	I	Y	i	y		˘						
A	LF		*	:	J	Z	j	z		˘						
B		ESC	+	;	K	[k	{	█	˘						
C			,	<	L	¥	l		█	˘						
D	CR		-	=	M]	m	}	█	˘						
E			.	>	N	^	n	~	█	˘						
F			/	?	O	—	o	Σ	+	˘						

Don't use codes A0→FF

AND

A&D Company, Limited

Daihatsu-Nissay Ikebukuro Bldg. 5F, 3-23-14 Higashi-Ikebukuro, Toshima-ku, Tokyo 170 Japan
Telephone: (03) 5391-6123 Fax: (03) 5391-6129 Telex: 02422816 AANDD J

A&D ENGINEERING, INC.

1555 McCandless Drive, Milpitas, CA 95035 U.S.A.
Telephone: (408) 263-5333 Fax: (408) 263-0119

A&D INSTRUMENTS GmbH

Lyoner Straße 36, D-6000 Frankfurt/Main 71, West Germany
Telephone: (069) 666-7006 Fax: (069) 666-6831 Telex: 417 0586 ANDI D

A&D MERCURY PTY. LTD.

32 Dew Street, Thebarton, South Australia 5031 Australia
Telephone: (08) 352-3033 Fax: (08) 352-7409